

ACOUSTIC
SIGNATURE

NEO SERIES



15 YEARS
WARRANTY

MADE IN
GERMANY

www.acoustic-signature.com

TURNTABLES

- 04 INVICTUS NEO
- 06 INVICTUS JR. NEO
- 08 ASCONA NEO
- 10 MONTANA NEO
- 12 TYPHOON NEO
- 14 VERONA NEO
- 16 HURRICANE NEO
- 18 TORNADO NEO
- 20 DOUBLE X NEO
- 22 MAXIMUS NEO
- 24 AVC-TECHNOLOGY
- 25 DTD-TECHNOLOGY
- 26 CLD-TECHNOLOGY
- 27 SILENCER-TECHNOLOGY

TONEARMS & PHONO PREAMPS

- 28 TA-9000 NEO
- 30 TA-7000 NEO
- 32 TA-5000 NEO
- 34 TA-2000 NEO
- 36 TA-1000 NEO
- 38 TA-500 NEO
- 39 TANGO REFERENCE
- 40 TANGO

ANALOG ACCESSORIES & CARTRIDGES

- 41 GRIP-S & LOAD-S
- 42 GRIP, LOAD & ACCESSORIES
- 43 CARTRIDGES

ACOUSTIC SIGNATURE NEO

We have been dedicated to vinyl playback for almost a quarter of a century. From the very beginning we knew what we wanted: to build the best turntables in the world. Turntables with manufacturing qualities that set new standards in surface quality and reliability. Turntables with state-of-the-art technologies that create soundscapes of extraordinary, soul enhancing beauty. Turntables that can easily pass as pure design objects. On the way to achieve these goals we can say that we have excited analog lovers all over the world and have received more awards and prizes from high-end journalists than most of our competitors. We have enriched the audio world with technical achievements now recognized as innovations by turntable experts the world over. Innovations such as our Silencer technology and the CLD (Constraint Layer Damping) technology have reduced turntable and chassis resonances to an unprecedented degree, whilst our maintenance-free Tidorfolon® bearing was defined by absence of noise and frictionless precision. We were among the first to rely on oversized, super stable power supplies and digital motor controllers. The list could go on, but as with any serious and honest research you reach a point where you must challenge your own achievements. Indeed, it was Jonathan Valin's radical endorsement: "... the ACOUSTIC SIGNATURE INVICTUS stands at the top." (The Absolute Sound 08/2016) that made us realize, that resting on our laurels wasn't an option. Thus the foundations were laid for developing the NEO series.

The fact is we questioned any of our existing technologies and searched for improvement ... and we have exceeded. We hired a renowned industrial designer to define the ultimate look for the new ACOUSTIC SIGNATURE NEO series, whilst we put every construction and material detail to the test, not even stopping at our own core technologies. Moreover, we brought on board a group of true sound experts composed of a team of different studio musicians, a conductor and two sound engineers to identify "potential technologies" for the NEO series from other professional perspectives. These experts were asked to judge their own recordings, helping us to determine whether our new developments were indeed producing a real sonic improvement. If a new technology could not convince all ears unanimously, it was either reconsidered and revised or discarded altogether. This is ultimately how we could guarantee that planning on the "drawing board", CAD design, "lab" experiments, assembly work and the team listening sessions formed an interrelated, coherent process. Results include new bearing materials for our tonearms, optimized CLD alloys for our chassis and further improved power supplies and control electronics for our drive systems.

Similarly, the recent debut of our AVC (Anti-Vibration Control) technology and DTD® (Dura Turn Diamond®) bearing with diamond-coated spindle sets new global standards in precision and robustness in analog technology. The development of the NEO series was time and cost intensive, but it also brought us to the next level – an enjoyment of sound now fully reflected in the design of our new turntables and tonearms. Indeed, we are proud to announce the ACOUSTIC SIGNATURE NEO series as a redefinition of future sound – a future that doesn't just take you close, but pulls you right into the center of music.

NEO



We could now write an essay on our INVICTUS NEO. No matter where you look – the ACOUSTIC SIGNATURE INVICTUS NEO is the best turntable in the world. Spot.

- 6 integrated, completely insulated AC-motors
- External digital motor controller DMC-20 with super stable multi-voltage power supply and innovative AVC-system level 3 (Anti-Vibration Control)
- Ultraprecise, extremely rigid and robust DTD®-bearing with diamond-coated spindle (Dura Turn Diamond® Bearing)
- Exclusive Silencer technology for effective reduction of platter vibration
- Massive aluminum chassis with CLD technology (Constraint Layer Damping) for significantly improved resonance behavior
- Integrated control panel
- 3-point setup with 3D-printed magnetic double-damping feet
- Prepared for up to 4 tone arms
- 15-year warranty (with registration)

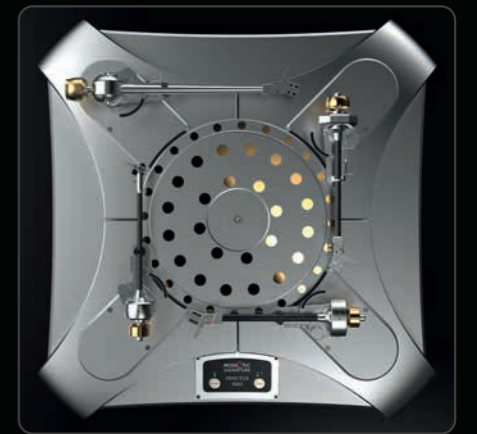

TECHNICAL DATA

Dimensions	710 x 710 x 270 (W x D x H / mm)	Platter	Oversized, anodized aluminum sandwich platter (Ø 335 x 50 mm / 16.5 kg) with brass layer, 24 inner and 32 outer Silencers (all Silencers made of polished brass, optional: 24 carat gold-plated or polished chrome)
Weight	130 kg	Tone arm base	up to 4 custom-made mounting boards for 9- to 12-inch tone arms
Drive System	6 AC-motors, belt drive with speed fine adjustment, AVC-system level 3	Colors	black (anodized), silver (anodized) or gold option
Speed range	33 1/3 RPM and 45 RPM, 78 RPM as option		
Power adapter	External power supply (100–260 V AC)		
Bearing	High-precision Dura Turn Diamond® Bearing		
Chassis	Massive aluminum chassis with special, height-adjustable damping feet		



The INVICTUS JUNIOR NEO was born out of the intention to offer the uncompromising concept of its "spiritual father", our reference turntable INVICTUS NEO, in a more compact design. To get as close as possible to the sonic "over" capabilities of the INVICTUS NEO, we have put all our knowledge of turntable construction and the essence of music into the development of the INVICTUS JUNIOR NEO. The result: a high mass turntable for those who don't want to settle for less than the best!

- 4 integrated, completely insulated AC-motors
- External digital motor controller DMC-20 with super stable multi-voltage power supply and innovative AVC-system level 3 (Anti-Vibration Control)
- Ultraprecise, extremely rigid and robust DTD®-bearing with diamond-coated spindle (Dura Turn Diamond® Bearing)
- Exclusive Silencer technology: reduction of platter vibration
- Massive aluminum chassis with CLD technology (Constraint Layer Damping) for significantly improved resonance behavior
- 3-point setup with special gel-damped feet
- Prepared for up to 4 tone arms
- Integrated control panel
- 15-year warranty (with registration)



TECHNICAL DATA

Dimensions	608 x 608 x 224 (W x D x H/ mm)	Platter	Oversized, anodized aluminum sandwich platter (Ø 335 x 50 mm / 16.5 kg) with brass layer, 24 inner and 32 outer Silencers (all Silencers made of polished brass, optional: 24 carat gold-plated or polished chrome)
Weight	108 kg	Tone arm base	up to 4 adjustable mounting boards for 9- to 12-inch tone arms
Drive System	4 AC-motors, belt drive with speed fine adjustment, AVC-system level 3	Colors	black (anodized), silver (anodized) or gold option
Speed range	33 1/3 RPM and 45 RPM		
Power adapter	External power supply (100–260 V AC)		
Bearing	High-precision Dura Turn Diamond® Bearing		
Chassis	93 mm aluminum alloy chassis with height-adjustable aluminum feet		

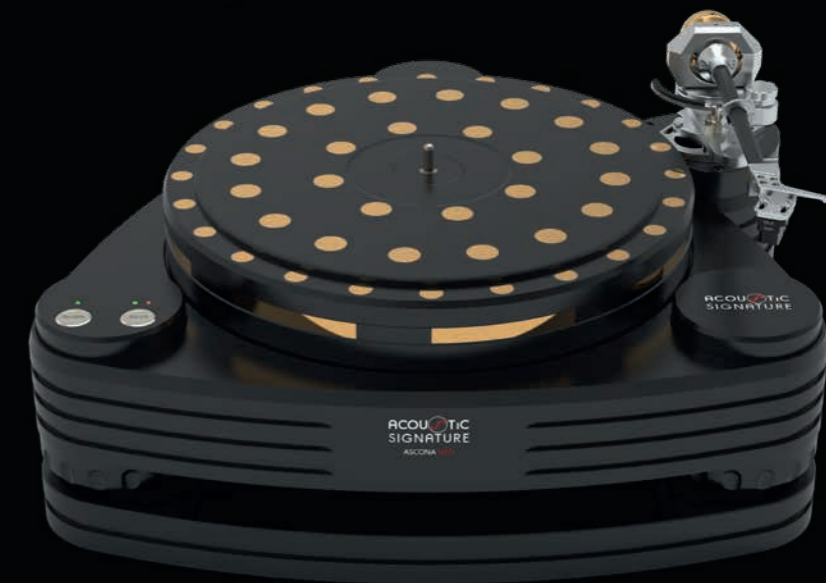

Welcome to the absolute Statement! With its supreme quietness and explosive dynamics, with its generous 3D-imaging and its fine sense for details, the ASCONA NEO is at the peak of what is sonically and technically feasible. This high mass turntable not only opens up a new era in our long company history: for many analog lovers the ACOUSTIC SIGNATURE ASCONA NEO will end a long search.

- 3 integrated, completely insulated AC-motors
- External digital motor controller DMC-20 with super stable multi-voltage power supply and innovative AVC-system level 3 (Anti-Vibration Control)
- Ultraprecise, extremely rigid and robust DTD®-bearing with diamond-coated spindle (Dura Turn Diamond® Bearing)
- Exclusive Silencer technology for effective reduction of platter vibration
- Massive aluminum chassis with CLD technology (Constraint Layer Damping) for significantly improved resonance behavior
- 3-point setup with special gel-damped feet
- Prepared for up to 3 tone arms
- Integrated control panel
- 15-year warranty (with registration)



TECHNICAL DATA

Dimensions	480 x 460 x 200 (W x D x H/ mm)	Platter	Oversized, anodized aluminum sandwich platter (Ø 335 x 50 mm / 16.5 kg) with brass layer, 24 inner and 32 outer Silencers (all Silencers made of polished brass, optional: 24 carat gold-plated or polished chrome)
Weight	58 kg	Tone arm base	up to 3 adjustable mounting boards for 9- to 12-inch tone arms
Drive System	3 AC-motors, belt drive with speed fine adjustment, AVC-system level 3	Colors	black (anodized) or silver (anodized)
Speed range	33 1/3 RPM and 45 RPM		
Power adapter	External power supply (100–260 V AC)		
Bearing	High-precision Dura Turn Diamond® Bearing		
Chassis	75 mm aluminum alloy chassis with height-adjustable aluminum feet		



In the planning phase of the MONTANA NEO, we put all our knowledge and innovative technologies into an absolutely world class high mass turntable with very compact dimensions. After intensive development work, we can now present an extremely attractive and flexible performer that has exceeded our own expectations and is unrivalled in its price range!

- 3 integrated, completely insulated AC-motors
- External digital motor controller DMC-20 with super stable multi-voltage power supply and innovative AVC-system level 3 (Anti-Vibration Control)
- Ultraprecise, extremely rigid and robust DTD®-bearing with diamond-coated spindle (Dura Turn Diamond® Bearing)
- Exclusive Silencer technology for effective reduction of platter vibration
- Massive aluminum chassis with CLD technology (Constraint Layer Damping) for significantly improved resonance behavior
- 3-point setup with special gel-damped feet
- Prepared for up to 2 tone arms
- Integrated control panel
- 15-year warranty (with registration)



TECHNICAL DATA

Dimensions	430 x 430 x 170 (W x D x H/mm)	Platter	Anodized aluminum platter (Ø 310 x 50 mm / 13 kg) with 24 Silencers (all Silencers made of polished brass, optional: 24 carat gold-plated or polished chrome)
Weight	37 kg	Tone arm base	up to 2 adjustable mounting boards for 9- to 12-inch tone arms
Drive System	3 AC-motors, belt drive with speed fine adjustment, AVC-system level 3	Colors	black (anodized), silver (anodized) or bi-color
Speed range	33 1/3 RPM and 45 RPM		
Power adapter	External power supply (100–260 V AC)		
Bearing	High-precision Dura Turn Diamond® Bearing		
Chassis	65 mm aluminum alloy chassis with height-adjustable aluminum feet		



The TYPHOON NEO knows almost no compromises! Prepared for 3 tonearms and equipped with the second-highest expansion stages of our newest drive system and chassis technologies, this high mass turntable will produce high audiophile waves – in the most positive sense. The overall performance of the ACOUSTIC SIGNATURE TYPHOON NEO is at a level that will beat some of the world's best and much more expensive turntables.

- 3 integrated, completely insulated AC-motors
- External digital motor controller DMC-20 with super stable multi-voltage power supply and innovative AVC-system level 2 (Anti-Vibration Control)
- Ultraprecise, extremely rigid and robust DTD®-bearing with diamond-coated spindle (Dura Turn Diamond® Bearing)
- Exclusive Silencer technology for effective reduction of platter vibration
- Massive aluminum chassis with CLD technology (Constraint Layer Damping) for significantly improved resonance behavior
- 3-point setup with special gel-damped feet
- Prepared for up to 3 tone arms
- Flexible placeable control panel
- 15-year warranty (with registration)



TECHNICAL DATA

Dimensions	450 x 460 x 190 (W x D x H/mm)	Platter	Anodized aluminum platter (Ø 310 x 50 mm / 13 kg) with 24 Silencers (all Silencers made of polished brass, optional: 24 carat gold-plated or polished chrome)
Weight	35 kg	Tone arm base	up to 3 adjustable mounting boards for 9- to 12-inch tone arms
Drive System	3 AC-motors, belt drive with speed fine adjustment, AVC-system level 2	Colors	black (anodized), silver (anodized) or bi-color
Speed range	33 1/3 RPM and 45 RPM		
Power adapter	External power supply (100–260 V AC)		
Bearing	High-precision Dura Turn Diamond® Bearing		
Chassis	75 mm aluminum alloy chassis with height-adjustable aluminum feet		



PIANO BLACK - SILVER



MAKASSAR - SILVER



PIANO BLACK - BLACK



MAKASSAR - BLACK

Turntables with a classic retro design are becoming increasingly popular. The new VERONA NEO can carry up to two 12-inch tonearms and thus offers all the possibilities that ambitious music lovers are looking for. In addition, it has all the technical refinements that its other brothers from the NEO series also have, such as a 2-motor drive concept, the DTD®-bearing and the external DMC-20 motor electronics with AVC Level 3 and the CLD design. Its 50 mm thick platter includes 8 silencers.

- 2 integrated, completely insulated AC-motors
- External digital motor controller DMC-20 with super stable multi-voltage power supply and innovative AVC-system level 3 (Anti-Vibration Control)
- Ultraprecise, extremely rigid and robust DTD®-bearing with diamond-coated spindle (Dura Turn Diamond® Bearing)
- Exclusive Silencer technology for effective reduction of platter vibration
- CLD technology (Constraint Layer Damping) for improved resonance behavior
- Optimized multi-sandwich chassis for higher rigidity and better acoustic properties
- 3-point setup with special gel-damped feet
- 15-year warranty (with registration)

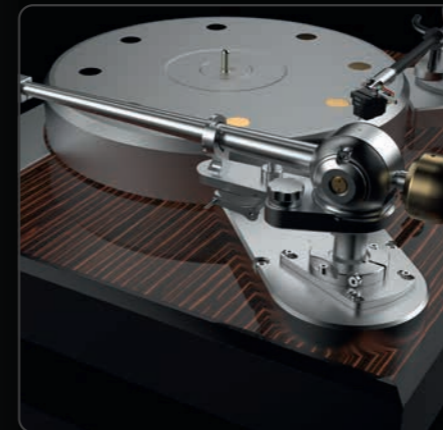

TECHNICAL DATA

Dimensions	544 x 449 x 166 (W x D x H/mm)	Chassis	Massive 65 mm sandwich chassis made of MDF, steel & plywood and with 3 height-adjustable aluminum feet
Weight	33 kg	Platter	Anodized aluminum platter (Ø 310 x 50 mm / 11 kg) with 8 Silencers (all Silencers made of polished brass, optional: 24 carat gold-plated or polished chrome)
Drive System	2 AC-motors, belt drive with speed fine adjustment, AVC-system level 3	Tone arm base	up to 2 mounting boards for 9 to 12-inch tone arms
Speed range	33 1/3 RPM and 45 RPM	Colors	Piano black or Piano black with glossy Makassar top surface, all Aluminum parts Silver anodized or Black anodized
Power adapter	External power supply (100–260 V AC)		
Bearing	High-precision Dura Turn Diamond® Bearing		



The HURRICANE NEO represents the entry into our multi-motor drive concept. The ACOUSTIC SIGNATURE HURRICANE NEO lives up to its name in terms of dynamics and belies all those "analog lovers" who claim that a high mass turntable cannot perform "explosively" and with fine dynamics at the same time. The HURRICANE NEO is prepared for 3 tonearms – offering an enormous amount of flexibility and musicality with exceptional value for the money. In short: HURRICANE NEO is a "Future Classic" that will raise a lot of audiophile dust!

- 2 integrated, completely insulated AC-motor
- External digital motor controller DMC-10 with super stable multi-voltage power supply and innovative AVC-system level 1 (Anti-Vibration Control)
- Ultraprecise, extremely rigid and robust DTD®-bearing with diamond-coated spindle (Dura Turn Diamond® Bearing)
- Exclusive Silencer technology for effective reduction of platter vibration
- Massive aluminum chassis with CLD technology (Constraint Layer Damping) for significantly improved resonance behavior
- 3-point setup with special gel-damped feet
- Prepared for up to 3 tone arms
- Flexible placeable control panel
- 15-year warranty (with registration)

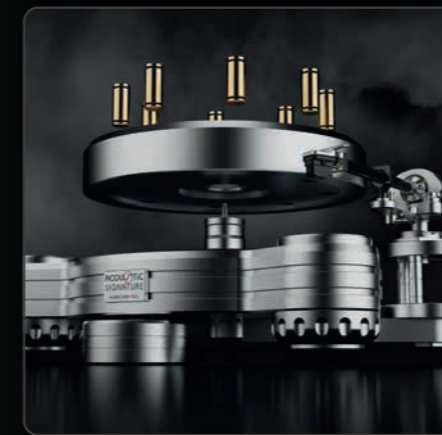

TECHNICAL DATA

Dimensions	450 x 460 x 175 (W x D x H/mm)	Platter	Anodized aluminum platter (Ø 310 x 50 mm / 11 kg) with 8 Silencers (all Silencers made of polished brass, optional: 24 carat gold-plated or polished chrome)
Weight	30 kg	Tone arm base	up to 3 adjustable mounting boards for 9- to 12-inch tone arms
Drive System	2 AC-motors, belt drive with speed fine adjustment, AVC-system level 1	Colors	black (anodized), silver (anodized) or bi-color
Speed range	33 1/3 RPM and 45 RPM		
Power adapter	External power supply (100–260 V AC)		
Bearing	High-precision Dura Turn Diamond® Bearing		
Chassis	50 mm aluminum alloy chassis with height-adjustable aluminum feet		



With the TORNADO NEO, we wanted to present a super flexible high mass turntable that would unleash audiophile forces far beyond its price range. Already prepared for 3 tonearms and equipped with our very latest innovative technologies, the ACOUSTIC SIGNATURE TORNADO NEO provides a captivating musical performance that will take even the most experienced analogists by storm.

- 1 integrated, completely insulated AC-motor
- External digital motor controller DMC-10 with super stable multi-voltage power supply and innovative AVC-system level 1 (Anti-Vibration Control)
- Ultraprecise, extremely rigid and robust DTD®-bearing with diamond-coated spindle (Dura Turn Diamond® Bearing)
- Exclusive Silencer technology for effective reduction of platter vibration
- Massive aluminum chassis with CLD technology (Constraint Layer Damping) for significantly improved resonance behavior
- 3-point setup with special gel-damped feet
- Prepared for up to 3 tone arms
- Flexible placeable control panel
- 15-year warranty (with registration)



TECHNICAL DATA

Dimensions	450 x 460 x 160 (W x D x H/mm)	Platter	Anodized aluminum platter (Ø 310 x 50 mm / 11 kg) with 4 Silencers (all Silencers made of polished brass, optional: 24 carat gold-plated or polished chrome)
Weight	26.5 kg	Tone arm base	up to 3 adjustable mounting boards for 9- to 12-inch tone arms
Drive System	1 AC-motor, double belt drive with speed fine adjustment, AVC-system level 1	Colors	black (anodized), silver (anodized) or bi-color
Speed range	33 1/3 RPM and 45 RPM		
Power adapter	External power supply (100–260 V AC)		
Bearing	High-precision Dura Turn Diamond® Bearing		
Chassis	45 mm aluminum alloy chassis with height-adjustable aluminum feet		



The elegant appearance of the DOUBLE X enjoys great popularity among analogists all over the world. The DOUBLE X has always stood for the perfect synthesis of modern technology and classic design. The DOUBLE X NEO continues this tradition and raises it to sound spheres that no high mass turntable in this price range has ever reached!

- 2 integrated, completely insulated AC-motor
- Integrated digital motor controller
- Innovative AVC-system level 1 (Anti-Vibration Control)
- Ultraprecise, extremely rigid and robust DTD®-bearing with diamond-coated spindle (Dura Turn Diamond® Bearing)
- Exclusive Silencer technology for effective reduction of platter vibration
- CLD technology (Constraint Layer Damping) for improved resonance behavior
- Optimized multi-sandwich chassis for higher rigidity and better acoustic properties
- 3-point setup with special gel-damped feet
- 15-year warranty (with registration)



TECHNICAL DATA

Dimensions	440 x 350 x 150 (W x D x H/mm)	Platter	Anodized aluminum platter (Ø 300 x 50 mm / 10.3 kg) with 8 Silencers (all Silencers made of polished brass, optional: 24 carat gold-plated or polished chrome)
Weight	24 kg	Tone arm base	For 9-inch tone arm
Drive System	1 integrated AC-motor, RPM-regulated belt drive with speed fine adjustment, AVC-system level 1	Colors	Piano black or Piano black with glossy Makassar top surface
Speed range	33 1/3 RPM and 45 RPM		
Power adapter	External power supply (100–260 V AC)		
Bearing	High-precision Dura Turn Diamond® Bearing		
Chassis	Massive 64 mm sandwich chassis made of MDF, steel & plywood and with 3 height-adjustable aluminum feet		



What is the reference product for other manufacturers is the starting point turntable for ACOUSTIC SIGNATURE. The MAXIMUS NEO, the successor of the popular MAXIMUS, already performs at a level that leaves many so-called "flagships" behind!

- Quiet AC-motor with external, super stable multi-voltage power supply
- Integrated digital motor controller
- Innovative AVC-system level 1 (Anti-Vibration Control)
- Ultraprecise, extremely rigid and robust DTD®-bearing with diamond-coated spindle (Dura Turn Diamond® Bearing)
- New and 30 % larger, resonance-reducing aluminum alloy chassis with aluminum platter
- 3-point setup with special gel-damped feet
- 15-year warranty (with registration)

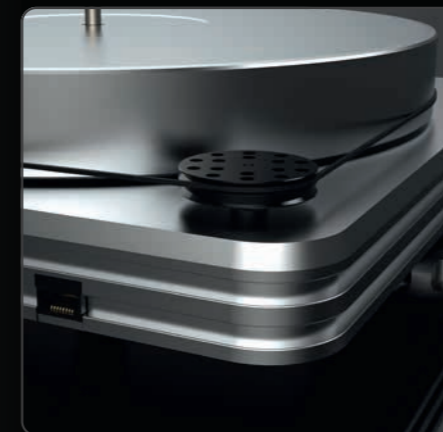

TECHNICAL DATA

Dimensions	415 x 315 x 120 (W x D x H / mm)	Chassis	30 mm massive aluminum chassis with 3 height-adjustable feet
Weight	18 kg	Platter	Ø 300 x 34 mm aluminum platter / 5.8 kg
Drive System	1 integrated AC-motor, RPM-regulated belt drive with speed fine adjustment, AVC-system level 1	Tone arm base	For 9-inch tonearm
Speed range	33 1/3 RPM and 45 RPM	Colors	black (anodized), silver (anodized) or bi-color
Power adapter	External power supply (100–260 V AC)		
Bearing	High-precision Dura Turn Diamond® Bearing		



ACOUSTIC SIGNATURE AVC (AUTOMATIC VIBRATION CONTROL)

Every rotating motor generates vibrations. This inevitable force is transmitted to the chassis and platter and consequently has a negative effect on the sonic performance of a turntable. Accordingly, it is important to effectively reduce undesired vibrations or even better prevent them from occurring in the first place – so much for the theory. Usually, this challenge is addressed by a focus on material selection, special measures for chassis and platter dampening, turntable setup and the design of the entire drive system including the motor selection. Due to budget and/or pricing policies, many manufacturers rarely consider a consistent combination of all the above measures. Apart from that, each developer will find out sooner or later that all those well-known approaches are limited – in terms of effectiveness. The concepts for vibration minimization only work up to a certain degree. But we wouldn't be ACOUSTIC SIGNATURE if we didn't go beyond the limits. In addition to our innovative "Silencer" and CLD (Constraint Layer Damping) technologies, we invented an additional milestone to reduce vibrations even further: ACOUSTIC SIGNATURE AVC – Automatic Vibration Control!

The vision of an "Automatic Vibration Control" was long born before the planning of our NEO series. During the development of our new turntable generation we found it was the right time to bring our ideas to life: The high-quality AC motors that drive our turntables are constructed with 2 coils and 24 poles. To make the coils rotate, they are "fed" with a sine wave and a 90° phase-shifted signal. Unfortunately all AC synchronous motors show produc-

tion-related tolerances that prevent the poles and coils from being positioned one hundred percent correctly – a key reason for unwanted vibrations. In order to effectively minimize or even avoid these, all production tolerances must be "compensated" by other means. This is where our AVC technology comes in: It is able to measure the resulting distortions in real time. Based on those measurements, AVC adjusts the phase shifts to the motor signals – also in real time and fully automatic! These digitally monitored "corrective measures" ensure a drastic reduction of the vibrations – an extra effective benefit for turntables driven by a multi-motor concept. The sonic gain is so dramatic that we decided to equip all NEO series turntables with that breakthrough technology. Depending on the drive system and the number of motors used, our Automatic Vibration Control is implemented in three configuration stages, each with different intensity: AVC Level 1, AVC Level 2 & AVC Level 3. All stages – Level 3 stands for the highest efficiency – use different software and hardware. In addition, from Level 2 on, the motors are strictly selected and paired to maximize the effect.



AVC Level 3 on the three motor powered Ascona NEO



AVC Level 3 on the six motor powered Invictus NEO



The Hurricane NEO is the entry to the multi motor concept



ACOUSTIC SIGNATURE DTD® BEARING: A CLASS OF ITS OWN!

The bearing is the heart of every turntable. Although the bearing design is of such great importance, its development – from the view of physics – is often characterized by imprecise to wrong approaches. Any conventional bearing that is "confronted" with a heavier platter is extremely sensitive in terms of handling. It also faces a mechanical challenge that is mainly to be found in the contact area of the thrust plate and bearing ball. In other words: the combination of the high platter weight and the very small ball surface causes an enormous pressure in the very small contact area, which simply pushes the lubricating oil away. The result: too much friction, too much noise, too much vibration and rapid wear. Analogists seeking salvation in an "inverted bearing" are misguided by a marketing trick: the main source of noise within a conventional bearing design is located at the pivot point of the platter axis and the thrust plate, about 4 inches away from the record. By inverting the bearing, this noise source is taken closer to the platter direct below the vinyl surface and thus into the activity area of the cartridge – definitely not a good idea. Moreover, this "reversal" causes a veritable lubrication problem thanks to gravity: the oil is floating away at the contact surface.

When we introduced our Tidorfolon® bearing in 1997, we immediately received enthusiastic feedback: made of a very innovative material combination, the Tidorfolon® bearing was hard enough not to be affected by the high mass of the platter and soft enough to withstand even a "dropped" plate without any damage. Another highlight: the material mix is able to absorb the oil like a sponge

and "release it when needed". In other words: the oil cannot be pushed away; the lubrication is always there when needed. Refill oil? Not necessary! Replenishment? Not necessary! Maintenance? Not necessary! Audiophiles and the specialist media worldwide have celebrated this extremely robust and low-noise bearing as a benchmark-setting innovation.

What's the improvement of the DTD® bearing: we succeeded in reducing the already imperceptible noise level caused by mechanical movement even further, thus making the famous "background" when listening to music even blacker. We achieved this by using newly developed sinter-bushes that can store three times the amount of lubricating oil. The design of the spindle was also put to the test. Our aim was to minimize its surface contact and the resulting noise. So, a vacuum-hardened stainless-steel spindle is grinded precisely and then subjected to an elaborate plasma coating. The result is a spindle with a diamond-like surface coating that competes with the hardest material on earth and reduces the friction coefficient by 60 percent! The Dura Turn Diamond® bearing is a super-rigid and virtually "indestructible" bearing that creates the best possible conditions for absolute high-end sound and sets new benchmark in terms of maintenance, low noise and service life – backed by a 15-years warranty. The DTD® bearing is manufactured for each turntable in the ACOUSTIC SIGNATURE NEO series in an individual version adapted to the respective turntable.



Tidorfolon® Bearing



Dura Turn Diamond® Bearing



Manufactured for each turntable of the ACOUSTIC SIGNATURE NEO series in an individual version adapted to the respective turntable



ACOUSTIC SIGNATURE CLD TECHNOLOGY (CONSTRAINT LAYER DAMPING)

"Constraint Layer Damping" (CLD) is a mechanical engineering method for the absorption or minimization of vibrations. In audio components CLD technology is usually implemented by using sandwich designs that "embed" a damping material layer between materials that do not themselves have sufficient damping properties. A cartridge will only track a record unaffected, if it finds a "quiet" surface without resonance interferences. Accordingly, it is necessary to develop "vibration-free" chassis and platter designs – this must be done in addition to the resonance-reducing measures for motors, drive and bearing construction.

In order to achieve this, we already extended the typical CLD technology approach more than 20 years ago. Beyond the classic sandwich construction, we presented an absolute novelty to the high-end world: the ACOUSTIC SIGNATURE "silencer" platter, which immediately set new standards in vibration absorption. Our "twin-track" CLD approach, which is mainly used in our high-mass turntables, is still unsurpassed in its effectiveness. In the course of planning and developing our NEO product line, we have been working intensively on improving our CLD concept.

First, our tests led to an optimized material combination consisting of two layers of a special aluminum alloy and an intermediate brass layer. Second, this also led to a new arrangement as well as an adjustment of size, weight and position of our "silencer" brass bolts when implemented in our platters. In addition, we had to "sensibly" pair the two CLD tools described above with the NEO chassis to

maximize the effect. The elaborate material experiments and listening sessions were worth the efforts: in our NEO turntable series we have succeeded in taking the interaction of all technologies to a stunning new level!

A rigid, yet energy-absorbing chassis based on finite element design principles, and our new CLD approach creates unbeatable units in terms of resonance behavior. The CLD technologies we implement in the ACOUSTIC SIGNATURE NEO turntable generation have clearly exceeded our metrological expectations and also show off in terms of sound performance – with an even blacker background, larger imaging, increased transparency and, above all, breathtaking musicality.

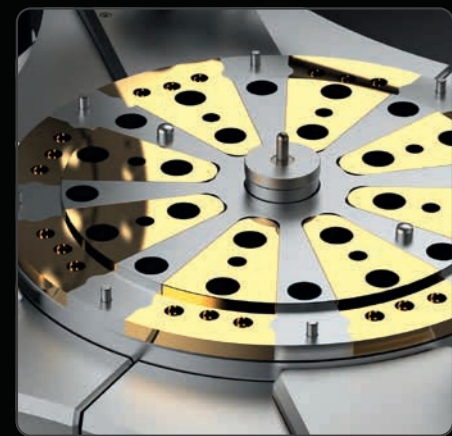

Special CLD sandwich-platter of the Invictus NEO



Invictus NEO with the CLD sandwich-platter and 56 silencer modules



Special CLD sandwich-platter of the Ascona NEO with 56 silencer modules

SILENCER-TECHNOLOGY

Since we invented the "Silencer-platter" in 2000 we have continuously improved the performance results and have now achieved platter damping that is unbeaten by any other product. The Silencers (made of polished brass, optional: 24 carat gold-plated or polished chrome) are of course visually attractive and make the ACOUSTIC SIGNATURE turntables even more desirable than without them but good looks was not the reason to implement them into our products.

The Silencers absorb and reduce vibrations whilst the vinyl disk is playing and you are listening. So, where do the vibrations come from, that we so wish to remove from the platter? There are several sources. First, the cartridge needle itself, playing a record causes vibrations and resonance in the vinyl, due to the movement of the needle tracking the record groove. It's easy to check by simply turning the volume down on your amplifier, you can still listen to the music directly from the needle/vinyl with your ear close to it. The needle is actually putting vibration back into the record as it tracks the groove, causing vibration in the whole vinyl record. This leads to "micro" mistracking of the cartridge, when picked up by the needle alongside the actual signal you want from the track, with a very small time delay between the two.

The Silencers in the platter absorb some of this unwanted vibration and improve the sound reproduction dramatically. The second source of vibration is airwaves hitting the platter and turntable body from your loudspeakers whilst you're listening to music. Your cartridge/stylus doesn't care where movement comes from, be it the grooves or other vibrations. Your cartridge simply produces an

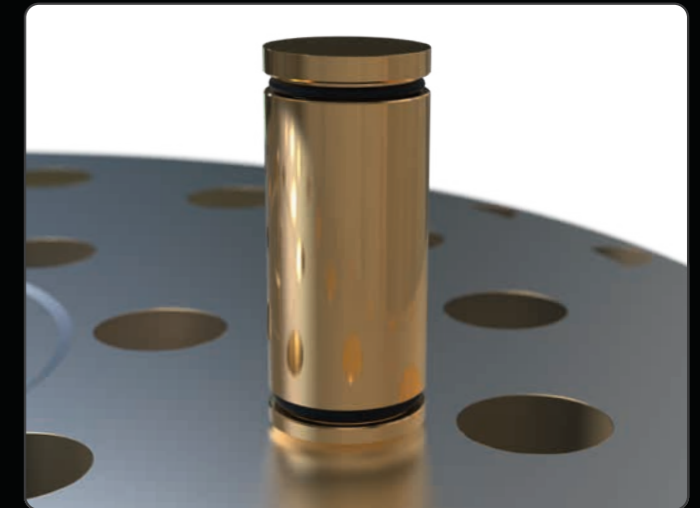

electrical signal when vibrating and all vibrations coming through the turntable will result in unwanted signals, resulting in a loss of detail resolution and imaging from your precious vinyl records. The Silencers absorb these unwanted vibrations, leading to a huge improvement in sound fidelity, improving your listening experience. To give you an idea how much the Silencers will improve the listening experience, we have conducted tests in an independent laboratory on two identical platters, one with and one without eight silencers fitted. The results are dramatic.

50 MM PLATTER & NO SILENCER

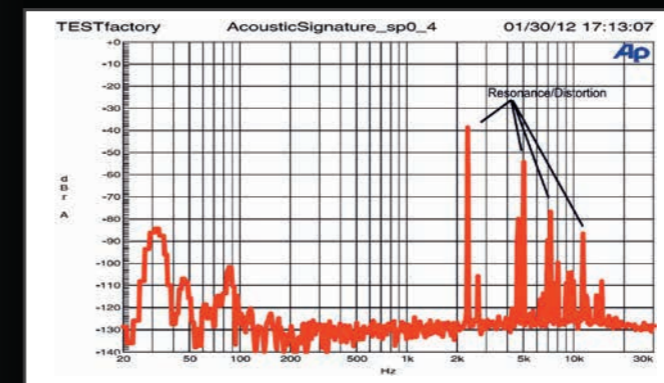

Here you see the ringing of an aluminum platter. A peak at about 2.2kHz and multiples up to 15 kHz. The peaks are more than 80dB louder than a damped platter!

50 MM PLATTER WITH 8 SILENCER

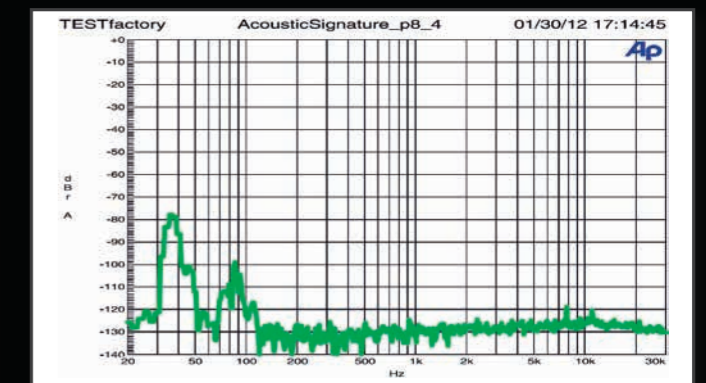

Here you see the result with 8 Silencers in the same aluminum platter. Virtually all resonances and peaks are removed. The Silencers dampen the resonances more than 80dB.



SILVER



BLACK



GOLD



CHROME

One of the most elaborate armtube designs in the history of high-end components, ball bearings used in astronautics which can hardly be surpassed in terms of precision and low friction, an innovative material symbiosis that has been thought out down to the smallest detail and that unites extreme rigidity and lightness as well as the ability to absorb vibrations: the TA-9000 NEO is made for the ultimate turntables.

- Extensively damped multi-structure aluminum armtube
- Very low resonance, ultra-rigid tube design
- Available as 9" and 12" version
- Perfect tracking results due to frictionless, pre-tensioned high-precision ball bearings by Timken
- Better rigidity and smooth operation due to NEO stainless steel tonearm axis design
- Internal high-purity silver wiring (4N)
- Supplied with external Audioquest 5-pin phono cable (1,5 m, RCA or XLR)
- Counterweight made of brass
- Adjustable VTA & azimuth
- SME-type mounting versions
- 5-year warranty (with registration)

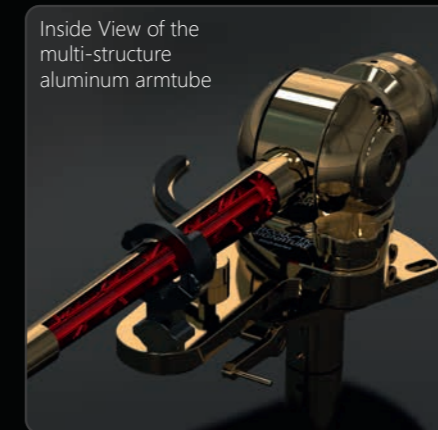

Inside View of the multi-structure aluminum armtube



TECHNICAL DATA

Length	298 mm (9" version) / 368 mm (12" version)	Effective mass	14.7 g (9" version) / 16.1 g (12" version)
Effective length	239.3 mm (9" version) / 309 mm (12" version)	Cartridge balance range	4 – 16 g
Mounting distance	222 mm (9" version) / 295.8 mm (12" version) (from pivot to center of platter)	Overhang	17.3 mm (9" version) / 13.2 mm (12" version)
Total weight	678 g (9" version) / 746 g (12" version)	Colors	Black / Silver / Gold-plated (24 carat) / Chrome-plated

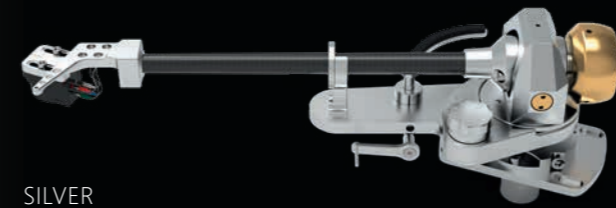
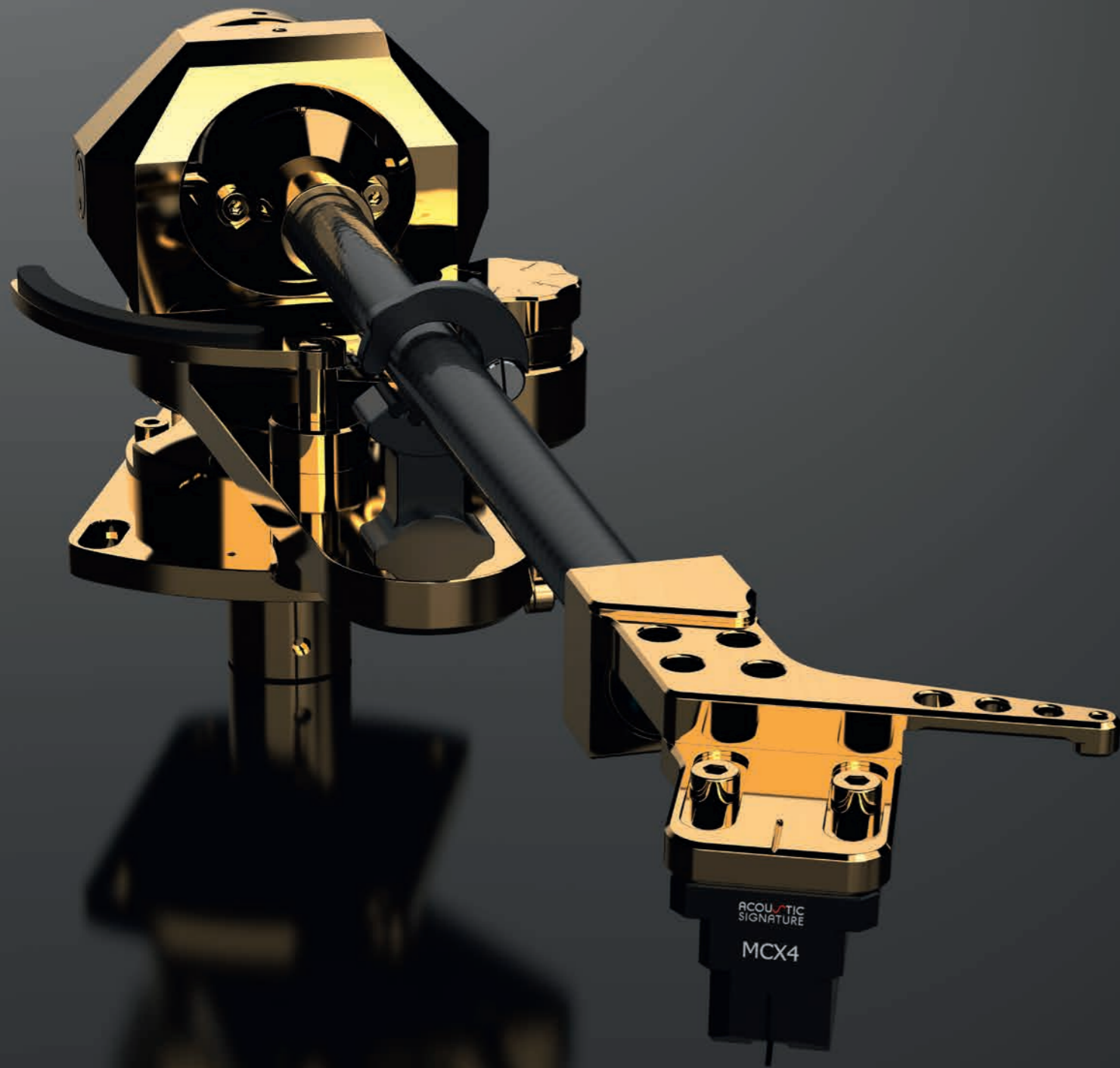

SILVER



BLACK

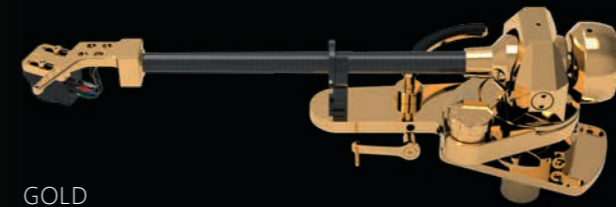

GOLD

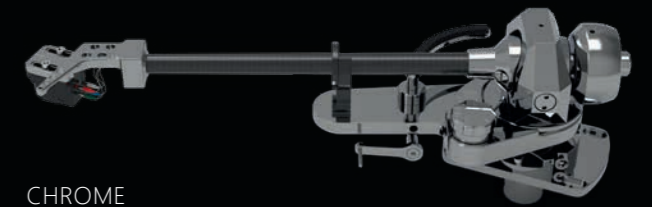

CHROME

Welcome to the absolute world class of tonearms! With its carbon armtube, its special inner construction, the ball bearings used in astronautics, the high-purity silver wiring and last but not least the famous manufacturing quality of ACOUSTIC SIGNATURE, the TA-7000 NEO is one of those tonearms which are rather limited by the choice of the cartridge or turntable. In short: the 9" and 12" versions of the TA-7000 NEO are made to be paired with the very best cartridges and turntables.

- Tonearm with 3D-damped carbon armtube
- Super-low resonance, extremely rigid and conical shaped tube design
- Available as 9" and 12" version
- Optimal tracking results due to pre-tensioned high-precision ball bearings
- Better rigidity and smooth operation due to NEO stainless steel tonearm axis design
- Internal high-purity silver wiring (4N)
- Supplied with external Audioquest 5-pin phono cable (1,5 m, RCA or XLR)
- Counterweight made of brass
- Adjustable VTA & azimuth
- SME-type mounting versions
- 5-year warranty (with registration)



Inside View of the 3D-damped carbon armtube



TECHNICAL DATA

Length	289 mm (9" version) / 358 mm (12" version)	Effective mass	10.2 g (9" version) / 13.9 g (12" version)
Effective length	239.3 mm (9" version) / 309 mm (12" version)	Cartridge balance range	4 – 16 g
Mounting distance	222 mm (9" version) / 295.8 mm (12" version) (from pivot to center of platter)	Overhang	17.3 mm (9" version) / 13.2 mm (12" version)
Total weight	678 g (9" version) / 687 g (12" version)	Colors	Black / Silver / Gold-plated (24 carat) / Chrome-plated

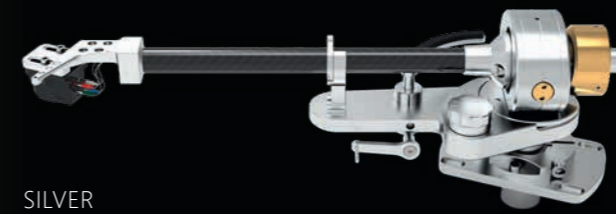
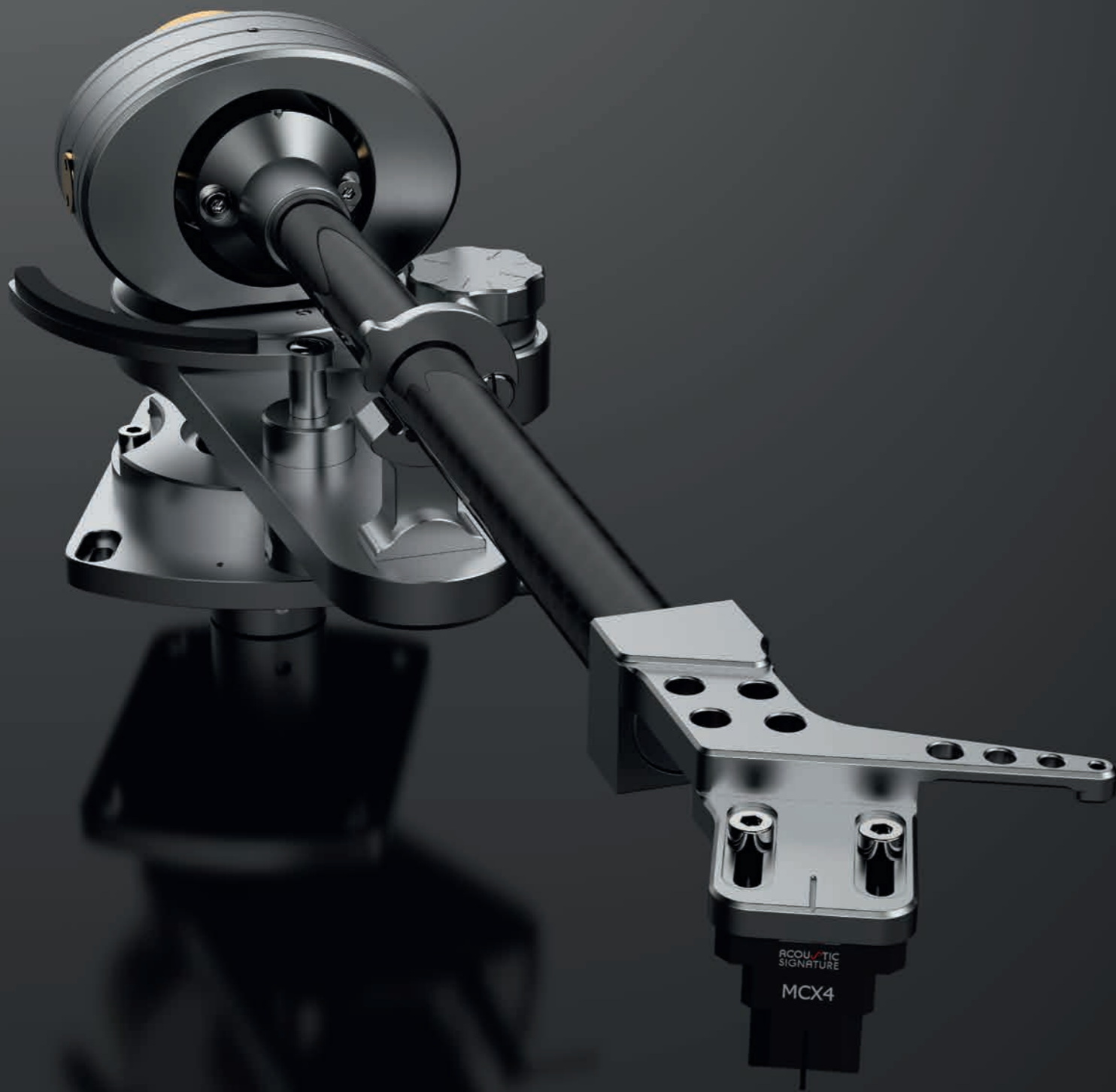

SILVER



BLACK

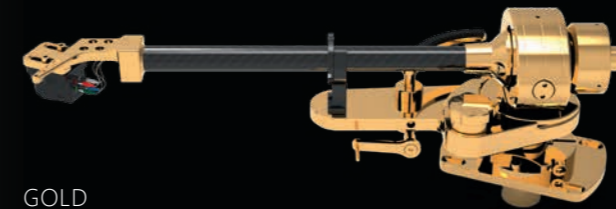

GOLD

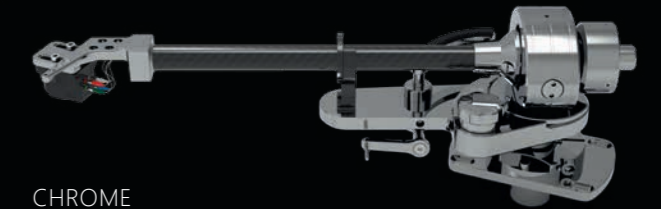

CHROME

When planning the TA-5000 NEO, one thought was at the forefront: to develop a tonearm at a fair price that has virtually no limitations. To realize this, it was necessary to break new ground. A high-precision hybrid ball bearings made of ceramic and stainless steel, 3 layers of carbon, connected via special damping elements with 2 tonearm tubes lying one inside the other, an internal cabling made of high-purity silver and our typical benchmark manufacturing quality culminate in an innovative tonearm that is always up against the best of its guild.

- Tonearm with triple-layer carbon armtube
- Low resonance, rigid tube design
- Available as 9" and 12" version
- Optimal tracking results due to pre-tensioned high-precision hybrid ball bearings by SKF
- Better rigidity and smooth operation due to NEO stainless steel tonearm axis design
- Internal high-purity silver wiring (4N)
- Supplied with external Audioquest 5-pin phono cable (RCA)
- Counterweight made of brass
- Adjustable VTA & azimuth
- SME-type mounting versions
- 5-year warranty (with registration)



TECHNICAL DATA

Length	289 mm (9" version) / 362 mm (12" version)	Effective mass	12.4 g (9" version) / 14.4 g (12" version)
Effective length	239.3 mm (9" version) / 309 mm (12" version)	Cartridge balance range	4 – 16 g
Mounting distance	222 mm (9" version) / 295.8 mm (12" version) (from pivot to center of platter)	Overhang	17.3 mm (9" version) / 13.2 mm (12" version)
Total weight	573 g (9" version) / 687 g (12" version)	Colors	Black / Silver / Gold-plated (24 carat) / Chrome-plated

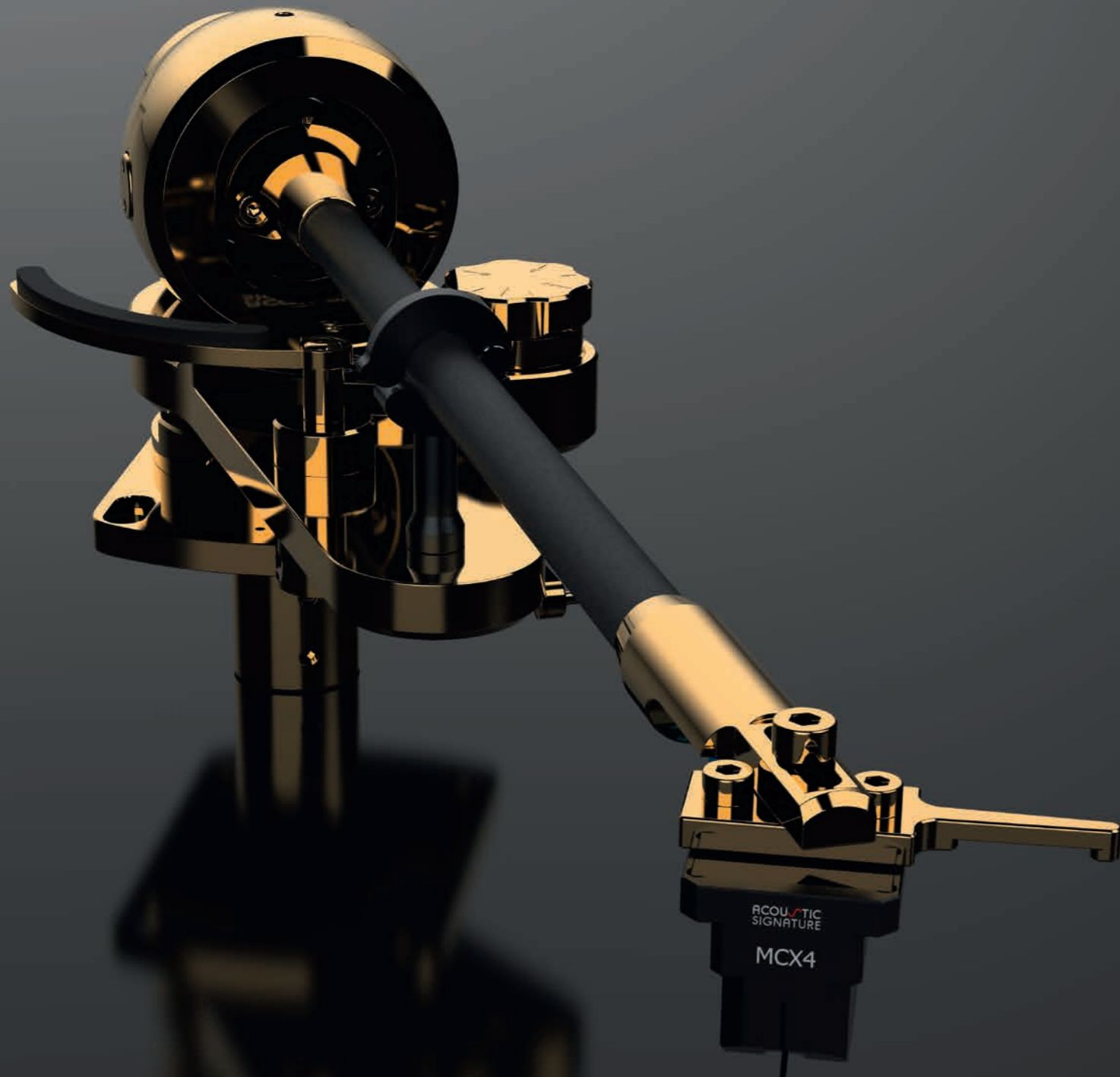

SILVER



BLACK



GOLD



CHROME

Our TA-2000 NEO undoubtedly plays with the "big boys" – not only because of the immaculate workmanship typical of ACOUSTIC SIGNATURE: the concept of this tonearm combines an extraordinarily stiff and at the same time well-damped dual-layer carbon tube with an almost frictionless precision ball bearings and a high-quality MOGAMI internal wiring. In short: a tonearm that harmonizes with most of the top range cartridges. Regardless if you decide for the 9" or 12" version: the ACOUSTIC SIGNATURE TA-2000 NEO ensures your turntable performance will not stay behind its possibilities.

- Tonearm with dual-layer carbon arm tube
- Low resonance, rigid tube design
- Available as 9" and 12" version
- Excellent tracking results due to precision miniature ball bearings by SKF
- Better rigidity and smooth operation due to NEO stainless steel tonearm axis design
- Internal studio-quality copper wiring by MOGAMI
- Supplied with external Audioquest 5-pin copper phono cable (RCA)
- Counterweight made of brass
- Adjustable VTA & azimuth
- Rega- and SME-type mounting versions
- 5-year warranty (with registration)



TECHNICAL DATA

Length	293 mm (9" version) / 358 mm (12" version)	Effective mass	9.6 g (9" version) / 12.6 g (12" version)
Effective length	239.3 mm (9" version) / 309 mm (12" version)	Cartridge balance range	4 – 16 g
Mounting distance	222 mm (9" version) / 295.8 mm (12" version) (from pivot to center of platter)	Overhang	17.3 mm (9" version) / 13.2 mm (12" version)
Total weight	545 g (9" version) / 547 g (12" version)	Colors	Black / Silver / Gold-plated (24 carat) / Chrome-plated



SILVER

BLACK

GOLD

CHROME

A well thought-out tonearm tube concept, an excellent bearing and the best materials: with our TA-1000 NEO you definitely don't give away any sound potential – not even on turntables that cost many times more. The TA-1000 NEO, available as 9" and 12" model, comes with high-quality MOGAMI cabling and is not only a fantastic match for ACOUSTIC SIGNATURE turntables.

- Tonearm with dual-layer carbon armtube
- Low resonance, rigid tube design
- Available as 9" and 12" version
- Excellent tracking results due to precision miniature ball bearings
- Better rigidity and smooth operation due to NEO stainless steel tonearm axis design
- Internal studio-quality copper wiring by MOGAMI
- Supplied with external Audioquest 5-pin copper phono cable (RCA)
- Counterweight made of brass
- Adjustable VTA & azimuth
- Rega- and SME-type mounting versions
- 5-year warranty (with registration)

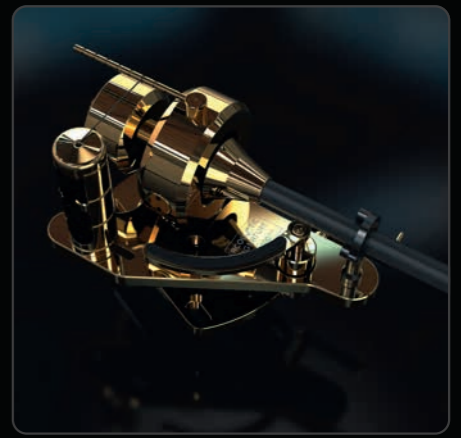
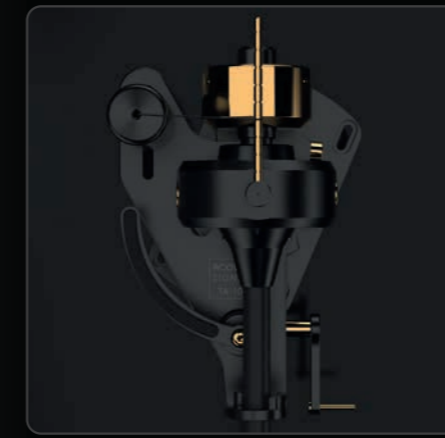

TECHNICAL DATA

Length	293 mm (9" version) / 370 mm (12" version)	Effective mass	9.3 g (9" version) / 12.3 g (12" version)
Effective length	239.3 mm (9" version) / 309 mm (12" version)	Cartridge balance range	4 – 16 g
Mounting distance	222 mm (9" version) / 295.8 mm (12" version) (from pivot to center of platter)	Overhang	17.3 mm (9" version) / 13.2 mm (12" version)
Total weight	439 g (9" version) / 442 g (12" version)	Colors	Black / Silver / Gold-plated (24 carat) / Chrome-plated

TA-500 NEO



SILVER

A turntable is only as good as its weakest link! As a matter of principle, we do not want to allow ourselves to call our "smallest" an entry-level tonearm. The TA-500 NEO is simply much too good for that!

- 9" tonearm with dual-layer carbon armtube
- Low resonance, rigid tube design
- Excellent tracking results due to precision miniature ball bearings
- Better rigidity and smooth operation due to NEO stainless steel tonearm axis design
- Internal studio-quality copper wiring by MOGAMI
- Supplied with external Audioquest 5-pin copper phono cable (RCA)
- Counterweight made of brass
- Adjustable VTA
- Rega-type mounting version
- 5-year warranty (with registration)



TECHNICAL DATA

Length	293 mm	Effective mass	10 g
Effective length	239.3 mm	Cartridge balance range	4 – 16 g
Mounting distance	222 mm	Overhang	17.3 mm
	(from pivot to center of platter)	Color	Silver
Total weight	349 g		

TANGO REFERENCE



Processing the delicate phono signal is one of the biggest challenges that amplifier designers have to face. That is why the ACOUSTIC SIGNATURE TANGO REFERENCE is undoubtedly the most elaborate phono preamplifier we have ever made. The resonance-optimized and anti-magnetic chassis made of a 70 mm thick and 22 kg solid aluminum block, makes it clear how serious we are about this phono equalizer. The over-dimensioned power supply with toroidal transformer is located on a separate board to ensure an absolute current stability. Both assemblies are mounted on a special shielding steel plate to avoid any interference with the phono signal.

The TANGO REFERENCE uses only highly selected quality components that are individually selected. In this way, its semi-active RIAA equalization achieves extremely accurate values with a maximum deviation of less than 0.1 dB from the ideal curve! The elaborate single-ended output stage was designed in Class A to guarantee minimal distortion as well as low hum and noise – the basis for high-resolution, fascinating 3D-imaging and involving musicality. With its selectable gain and 90-steps load impedance configuration, the TANGO REFERENCE also offers optimal matching options for any high-quality MM and MC cartridge.

- Phono preamplifier for MC, MI & MM cartridges
- Resonance-optimized and antimagnetic aluminum chassis
- Super precise RIAA and extremely low distortion due to high quality components and single-ended output stage (Class A)
- Extremely low hum & noise due to very short signal paths
- External, over-dimensioned power supply
- Subsonic filter against low-frequency interferences
- 4 selectable gain steps
- Adjustable load impedance via 90-steps DIP switch

TECHNICAL DATA

Amplification MM / MCH / MCL	42 dB / 54 dB / 66 dB	Signal-to-noise ratio MM / MC	89 dB / 74 dB
Input connection MM / MC (Cinch)	Switchable	Subsonic filter	Yes
Output connection (Cinch)	Unbalanced (RCA)	Weight	16 kg
Operation voltage (external power supply)	24 V DC	Size (W x D x H)	424 x 244 x 80 mm
Channel separation	> 92 dB (1 kHz)	Colors	Black (anodized), Silver (anodized)
RIAA accuracy	± 0,1 dB	Warranty	2 years



The ACOUSTIC SIGNATURE TANGO MK3 phono preamplifier definitely plays like a "big one": The resonance-optimized, anti-magnetic chassis is made of a solid aluminum block. The double-sided circuit board is exclusively equipped with quality components from established brand manufacturers and layouted in SMD design to keep the signal paths as short as possible.

In order to ensure absolute power stability and no risk of interferences with the phono signal, our over-dimensioned power supply is external. The RIAA equalization of the TANGO MK3 delivers extremely accurate values with a maximum deviation of less than 0.2 dB from the ideal curve! The complex circuit design features additional local electrolytic capacitors for stabilization and an effective subsonic filter that guarantees minimal distortion as well as maximum hum and noise reduction. With its selectable gain and DIP switch for load impedance configuration the TANGO MK3 also offers a variety of adjustment options for many MC and all MM cartridges.

- Phono preamplifier for MC, MI & MM cartridges
- Resonance-optimized and antimagnetic aluminum chassis
- Precise RIAA and extremely low distortion due to quality components
- Extremely low hum & noise due to short signal paths
- External, over-dimensioned power supply
- Subsonic filter against low-frequency interferences
- 2 selectable gain steps
- Adjustable load impedance via DIP switch

TECHNICAL DATA

Amplification MM / MCH / MCL 40 dB / 60 dB
 Input connection MM / MC (Cinch) Switchable
 Output connection (Cinch) Unbalanced (RCA)
 Operation voltage (external power supply) 24 V DC
 Channel separation > 89 dB (1 kHz)
 RIAA accuracy ± 0,2 dB

Signal-to-noise ratio MM / MC 83 dB / 65 dB
 Subsonic filter Yes
 Weight 2,1 kg
 Size (W x D x H) 162 x 98 x 57 mm
 Colors Silver (anodized)
 Warranty 2 years

GRIP-S

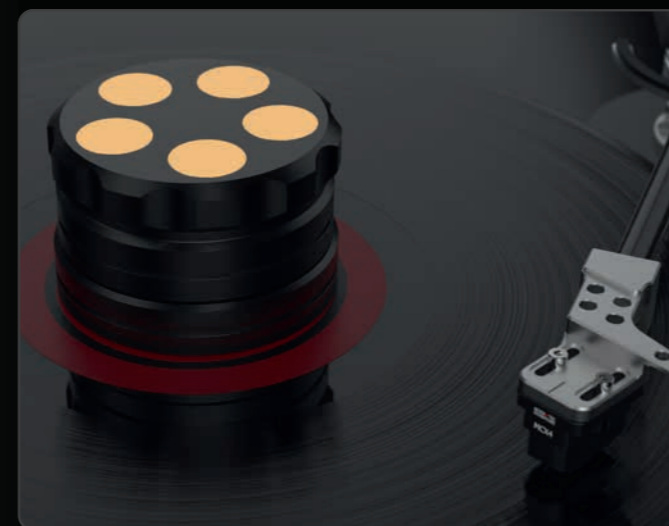

The ACOUSTIC SIGNATURE record clamp GRIP-S is a highly innovative design that eliminates record groove noise revealing a new level of musical performance. It is manufactured with our proprietary Silencer technology invented by ACOUSTIC SIGNATURE. The aluminum body is CNC lathed for perfect alignment and balance. The Silencers used at the GRIP-S are made of copper and absorb resonances very effective. They are pressed into the metal of the GRIP-S. This record clamp has a total mass of 752 gram and is designed to be used with a wide range of turntable from mid to



high mass turntable. designs (15 lb platter and higher). For lighter constructions and sub-chassis players we suggest to use our regular GRIP.

GRIP-S with its metal part manufactured from a high quality heat treated aluminum alloy is available in 3 colors: Silver or black anodized or high gloss non anodized. All versions of the GRIP-S deliver the same performance.

LOAD-S



The ACOUSTIC SIGNATURE record weight LOAD-S is a highly innovative design that eliminates record groove noise revealing a new level of musical performance. It is manufactured with our proprietary Silencer technology invented by ACOUSTIC SIGNATURE. The aluminum body is CNC lathed for perfect alignment and balance. The Silencers used at the LOAD-S are made of copper and absorb resonances very effective. They are pressed into the metal of the LOAD-S. This record weight has a total mass of 715 gram and is designed to be used with a wide range of turntable from

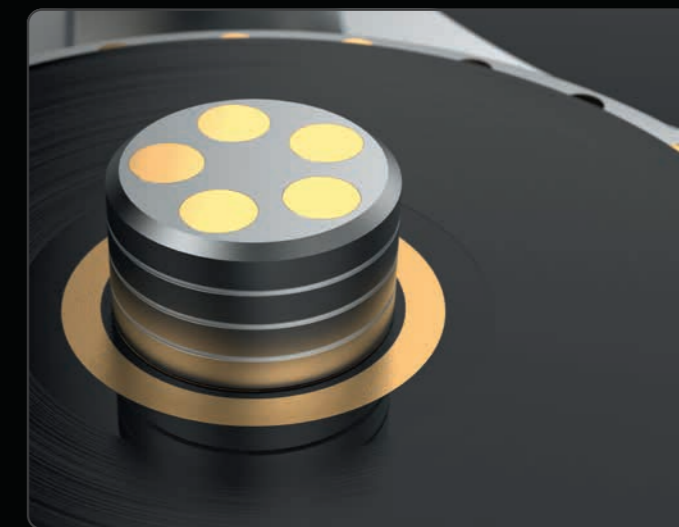

mid to high mass turntable designs (15 lb platter and higher). For lighter constructions and sub-chassis players we suggest to use our regular LOAD.

LOAD-S with its metal part manufactured from a high quality heat treated aluminum alloy is available in 3 colors: Silver or black anodized or high gloss non anodized. All versions of the LOAD-S deliver the same performance.

GRIP, LOAD & ACCESSORIES



GRIP

Designed for our ACOUSTIC SIGNATURE turntables, it can also be used with almost any turntable. The GRIP gives you more pressure to the record as it is clamping on the platter spindle. The weight is 315 gram, height is 44 mm and the diameter is 74 mm and easy use. The GRIP is available in 3 colors: Silver or black anodized or high gloss non anodized.



REGA SPACER SET

Perfect accessory to adjust the height of rega tonearms without removing them. Adjustment possible from 0,5 up to 3,5 mm for Set 1 and up to 6,5 mm with Set 2. Adjustment possible in steps of 0,5 mm.

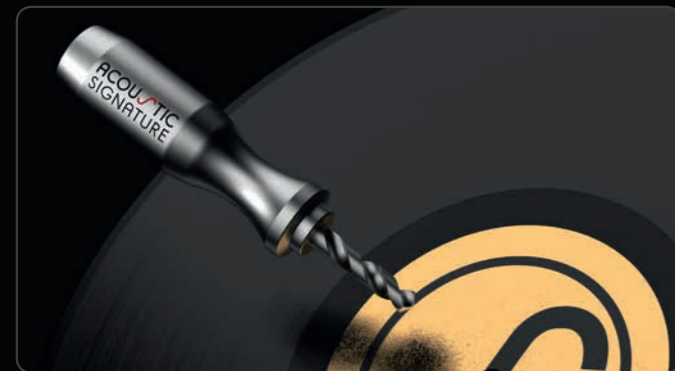

LOAD

Designed for our ACOUSTIC SIGNATURE turntables, it can also be used with almost any turntable. The weight is 280 gram, height is 42 mm and the diameter is 68 mm. It provides great contact between record and platter and easy use. The LOAD is available in 3 colors: Silver or black anodized or high gloss non anodized.



BUBBLE LEVEL

Dual axis bubble level: Easy and precise leveling for turntables in one step.

DRILLER

Who does not know that. From time to time the plate just does not go easy on the plate axis. In this case we have developed the ultimate tool: a vinyl drill, built for eternity. A solid aluminum handle with 25 mm diameter and 85 mm length ensures that it lies perfectly in the hand. Manufactured on "State of the Art"-CNC machines in our factory.

The drill is not, as is often the case with competitors, a cheap roll-rolled drill, but a ground drill made by GÜHRING, Germany's market leader in drilling. We just did not want to compromise here. Everything "Made in Germany". No ifs and buts.

CARTRIDGES

MCX SYSTEM

At ACOUSTIC SIGNATURE we constantly look for new technology to be used in our products and push the performance of existing technology to a new level. In 2015 we introduced a new series of MC cartridges to the market which was very successful. Based on this experience we decided to develop a new cartridge line that pushes the level higher. By carefully implementing new manufacturing technology and resonance control techniques for the CNC machined housing of the cartridge we created this fantastic new series of cartridges called MCX series.



MCX1

The ACOUSTIC SIGNATURE MCX1 is a modern moving-coil cartridge, manufactured according to the latest technologies – the optimal partner for our NEO tonearm series. An elliptical stylus assuring precise tracking results, copper coils and a CNC-milled and resonance-optimized chassis developed according to the finite element design principle form the basis for a true all-rounder.

- Modern MC cartridge with copper coils
- Resonance-optimized aluminum chassis
- Easy mounting
- Precise tracking due to elliptical stylus
- Suitable for medium to high mass tonearms



MCX2

The ACOUSTIC SIGNATURE MCX2 is a modern moving-coil cartridge, manufactured according to the latest technologies – the optimal partner for our NEO tonearm series. A 'nude' elliptical stylus assuring precise tracking results, high-purity silver coils and a CNC-milled and resonance-optimized chassis developed according to the finite element design principle form the basis for a sovereign sounding cartridge.

- Modern MC cartridge with high-purity silver coils
- Resonance-optimized aluminum chassis
- Easy mounting
- Precise tracking due to nude elliptical stylus
- Suitable for medium to high mass tonearms



MCX3

The ACOUSTIC SIGNATURE MCX3 is a modern moving-coil cartridge, manufactured according to the latest technologies – the optimal partner for our NEO tonearm series. A 'nude' fine line stylus assuring best tracking results, high-purity copper coils and a CNC-milled and resonance-optimized chassis developed according to the finite element design principle form the basis for a first-class cartridge.

- Modern MC cartridge with high-purity copper coils
- Resonance-optimized aluminum chassis
- Easy mounting
- Excellent tracking due to the nude fine line stylus
- Suitable for medium to high mass tonearms



MCX4

The ACOUSTIC SIGNATURE MCX4 is our flagship! This modern moving-coil cartridge is manufactured according to the latest technologies – the optimal partner for our NEO tonearm series. A 'nude' Shibata stylus assuring perfect tracking results, gold-plated coils made of oxygen-free copper and a CNC-milled and resonance-optimized chassis developed according to the finite element design principle form the basis for an absolute top-class cartridge.

- Modern MC cartridge with gold-plated, oxygen-free copper coils
- Resonance-optimized aluminum chassis
- Easy mounting
- Excellent tracking due to nude Shibata stylus
- Suitable for medium to high mass tonearms

ACOUSTIC
SIGNATURE

AS-Distribution GmbH
Manufacturer of
ACOUSTIC SIGNATURE

Hillenbrandstraße 10
73079 Sößen/Germany

Phone +49 7162 20797-0
E-Mail info@as-distribution.de

www.acoustic-signature.com